

BLUE STAR

Power Systems Inc.

Diesel Product Line

208-4160 Volt

MD1000-01

60 Hz / 1800 RPM

1000 kWe

Standby

Ratings

	208V	240V	480V	600V	4160V
Phase	3	3	3	3	3
PF	0.8	0.8	0.8	0.8	0.8
Hz	60	60	60	60	60
Generator Model	741RSL4045	741RSL4045	575RSL4044	741RSS4282	742FSM4364
Connection	12 LEAD WYE	12 LEAD DELTA	4 LEAD WYE	4 LEAD WYE	6 LEAD WYE
Standby					
kWe	1000	1000	1000	1000	1000
AMPS	3474	3011	1505	1204	174
Temp Rise	130°C / 27°C	130°C / 27°C	130°C / 27°C	130°C / 27°C	130°C / 27°C

Standard Equipment

- | | | |
|--|--|--|
| <p>Engine</p> <ul style="list-style-type: none"> ▶ Radiator Cooled Unit Mounted (50°C) ▶ Blower Fan & Fan Drive ▶ Starter & Alternator ▶ Oil Pump & Filter ▶ Oil Drain Extension w/Valve ▶ Governor - Electronic Isochronous ▶ 24V Battery System & Cables ▶ Air Cleaner (Dry Single Stage) ▶ Flexible Fuel Connector ▶ EPA Certified Tier 2 <p>Listing Certifications</p> <ul style="list-style-type: none"> ▶ UL 2200 Listed* ▶ cUL Listed* ▶ CSA Certified* ▶ Seismic Certified to IBC 2018 | <p>Generator</p> <ul style="list-style-type: none"> ▶ Brushless Single Bearing ▶ Automatic Voltage Regulator ▶ ± .25% Voltage Regulation ▶ 4 Pole, Rotating Field ▶ 130°C Standby Temperature Rise ▶ 100% of Rated Load - One Step ▶ 5% Maximum Harmonic Content ▶ NEMA MG 1, IEEE and ANSI Standards Compliance for Temperature Rise | <p>Additional</p> <ul style="list-style-type: none"> ▶ Microprocessor Based Digital Control ▶ Interface Connection Box ▶ Control Panel Mounted in NEMA 12 Enclosure ▶ Base - Structural Steel ▶ Main Line Circuit Breaker Mounted & Wired* ▶ Critical Grade Silencer Mounted ▶ Battery Charger 24V 5 Amp ▶ Jacket Water 2 Qty: 9000W 240V w/Isolation Valves ▶ Vibration Isolation Mounts (Pad Type) ▶ Radiator Duct Flange (OPU Only) ▶ Single Source Supplier ▶ 2YR / 2000HR Standby Warranty ▶ Standard Colors - White / Gray |
|--|--|--|

*Through 600VAC

Application Data

Engine			
Manufacturer:	Mitsubishi	Displacement - Cu. In. (lit):	2,265 (37.1)
Model:	S12H-Y2PTAW-1	Bore - in. (cm) x Stroke - in. (cm):	5.91 (15.0) x 6.89 (17.5)
Type:	4-Cycle	Compression Ratio:	14.5:1
Aspiration:	Turbo Charged, H ₂ O/Air Intercooled	Rated RPM:	1800
Cylinder Arrangement:	12 Cylinder Vee	Max HP Stby (kWm):	1,528 (1,140)

Exhaust System	Standby
Gas Temp. (Stack): °F (°C)	910 (488)
Gas Volume at Stack Temp: CFM (m ³ /min)	9,534 (270)
Maximum Allowable Exhaust Restriction: in. H ₂ O (kPa)	23.6 (5.90)

Cooling System	
Ambient Capacity of Radiator: °F (°C)	122 (50.0)
Maximum Allowable Static Pressure on Rad. Exhaust: in. H ₂ O (kPa)	0.50 (0.12)
Jacket Water Pump Flow Rate: GPM (lit/min)	383 (1,450)
Intercooler Pump Flow Rate: GPM (lit/min)	132 (500)
Heat Rejection to Coolant: BTUM (kW)	23,715 (415)
Heat Rejection to Intercooler: BTUM (kW)	18,633 (326)
Heat Radiated to Ambient: BTUM (kW)	5,082 (89.4)

Air Requirements	
Aspirating: CFM (m ³ /min)	3,602 (102)
Air Flow Required for Rad. Cooled Unit: CFM (m ³ /min)	42,191 (1,194)
Air Flow Required for Heat Exchanger/Rem. Rad. CFM (m ³ /min)	Consult Factory For Remote Cooled Applications

Fuel Consumption	
At 100% of Power Rating: gal/hr (lit/hr)	75.0 (284)
At 75% of Power Rating: gal/hr (lit/hr)	59.7 (226)
At 50% of Power Rating: gal/hr (lit/hr)	39.8 (151)

Fluids Capacity	
Total Oil System: gal (lit)	52.8 (200)
Engine Jacket Water Capacity w/Intercooler: gal (lit)	26.4 (100)
System Coolant Capacity: gal (lit)	115.2 (436)

Deration Factors

Rated power available up to 3280 ft (1000 m) at ambient temperatures to 104°F (40°C).
Consult factory for site conditions above these parameters.

DGC-2020 Control Panel

Standard Features

- ▶ Digital Metering
- ▶ Engine Parameters
- ▶ Generator Protection Functions
- ▶ Engine Protection
- ▶ CAN Bus ECU Communications
- ▶ Windows-Based Software
- ▶ Multilingual Capability
- ▶ Remote Communications to RDP-110 Remote Annunciator
- ▶ 16 Programmable Contact Inputs
- ▶ Up to 15 Contact Outputs (7 standard)
- ▶ UL Recognized, CSA Certified, CE Approved
- ▶ Event Recording
- ▶ IP 54 Front Panel Rating with Integrated Gasket
- ▶ NFPA 110 Compatible



Weights / Dimensions / Sound Data

	L x W x H	Weight lbs
OPU	210 x 96 x 102 in	22,675
Level 1	210 x 96 x 108 in	25,375
Level 2	210 x 96 x 108 in	25,525
Level 3	285 x 96 x 108 in	26,725

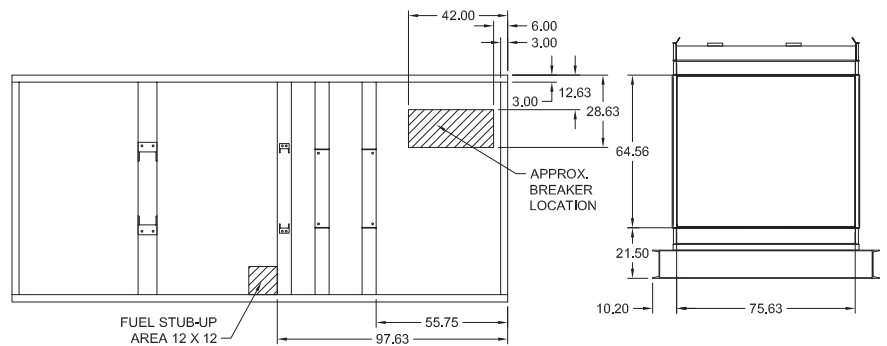

	No Load	Full Load
OPU	87 dBA	89 dBA
Level 1	81 dBA	83 dBA
Level 2	79 dBA	81 dBA
Level 3	75 dBA	77 dBA

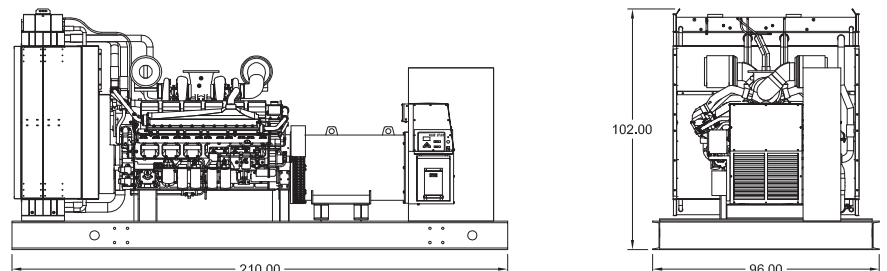

Drawings based on standard open power 480 volt standby generator. Lengths may vary with other voltages. Subject to change without notice. Sound data as measured at 23 feet (7 meters) in accordance with ISO 8528-10 at standby rating.

Enclosures

Level 1 & 2 | Side View (Weather Proof)

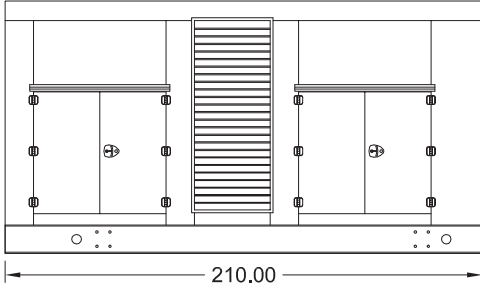

Level 3 | Side View (Sound Attenuated)

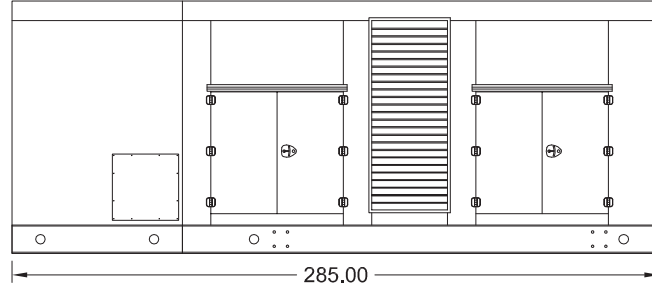

Level 1, 2 & 3 | Intake View

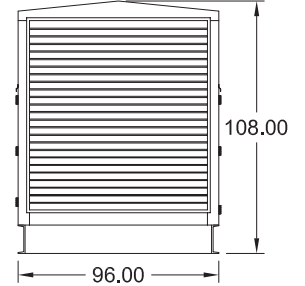

All enclosures are 150 MPH Wind Rated.

Level 2 & 3 enclosures include sound attenuation foam.

Level 3 enclosure includes frontal sound & exhaust hood.

*Enclosure height does not include exhaust system.

Double Wall UL 142 Listed Fuel Tanks

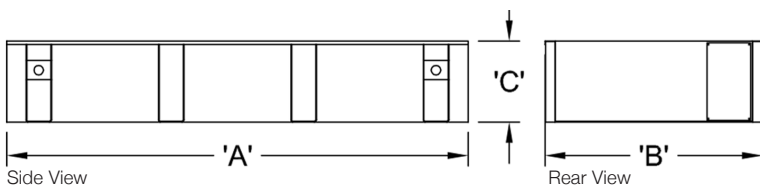
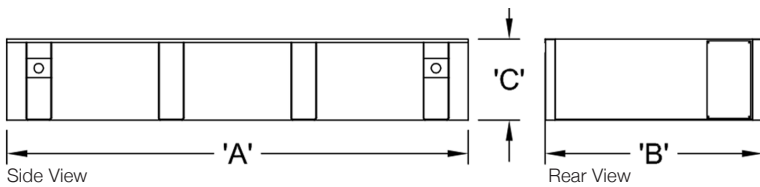

OPU / Level 1 / Level 2			
	12 Hour 900 Gallon	24 Hour 1800 Gallon	48 Hour 3600 Gallon
A	210.00	210.00	348.00
B	96.00	96.00	96.00
C	16.00	30.00	36.00

Level 3			
	12 Hour 900 Gallon	24 Hour 1800 Gallon	48 Hour 3600 Gallon
A	285.00	285.00	348.00
B	96.00	96.00	96.00
C	12.00	22.00	36.00

All specification sheet dimensions are represented in inches.

All enclosures and fuel tanks are based on the standard standby unit configuration. Any deviation can change dimensions.

Materials and specifications subject to change without notice.

American Owned



American Made

Distributed By:

Blue Star Power Systems, Inc.

2250 Carlson Drive

North Mankato, Minnesota 56003

Phone + 1 507 345 1776

bluestarps.com

quote.bluestarps.com

sales@bluestarps.com